



REFINED & SLEEK 3-D ACOUSTIC PANELS

SONIC DESIGN FORM[®]

LAMVIN

SONIC DESIGN FORM

3-DIMENSIONAL WALL AND CEILING PANELS

Our unique molded shapes offer endless design options and provide vital acoustic results. Refined and sleek, choose the shape that meets your design aesthetic. If sustainability is a concern or corporate mission, choose Sonic Design Form with a formaldehyde-free Eco-Sonic core.



lamvin.com/sonic-design-form



DIAMOND



DIAMOND

OUR MOST VERSATILE SONIC DESIGN FORM.

These panels offer an array of design possibilities. Whether you're looking for a unique acoustical solution for the ceilings or walls - The Diamond combines the flexibility of a multitude of configurations and acoustical fabric options.

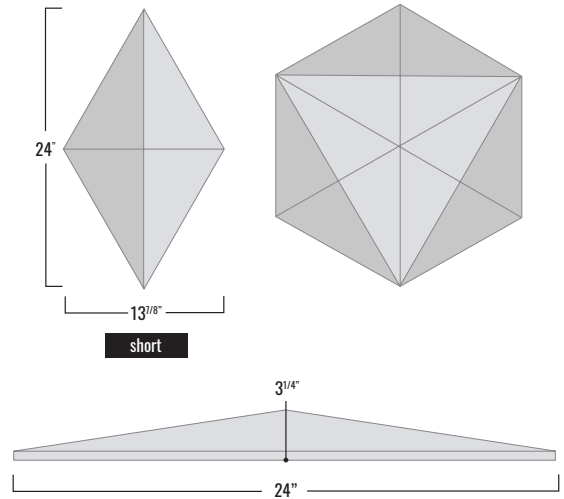

Available in short and tall thicknesses



ARCH



ARCH

A VISUAL STUNNER. Arch panels work well in any environment. Pair them with a natural fiber acoustical fabric for a more rustic vibe or create a pattern with pops of color for a modern feel. These panels will be the focal point of any room.

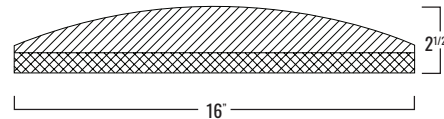

Available in three standard sizes:
Small, Medium and Large. Custom
sizes can be special ordered

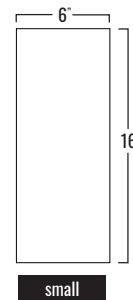



KEYSTONE

DEFINED AS THE MOST IMPORTANT PART OF ANYTHING.

You will certainly feel that way when you see how the Sonic Design Form Keystone enhances a room. This panel brings so many design options to the table. The unique shape works well with almost any acoustical fabric or wood veneer covering.

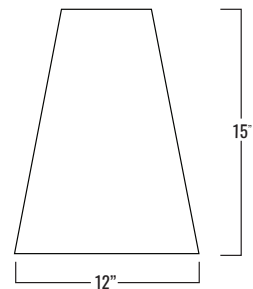
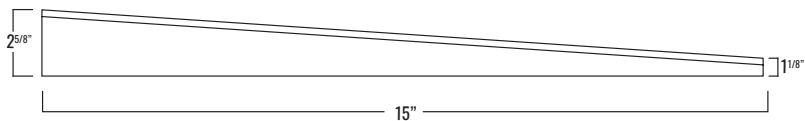

small

**Available in three standard sizes: Small, Medium and Large.
Custom sizes can be special ordered.**

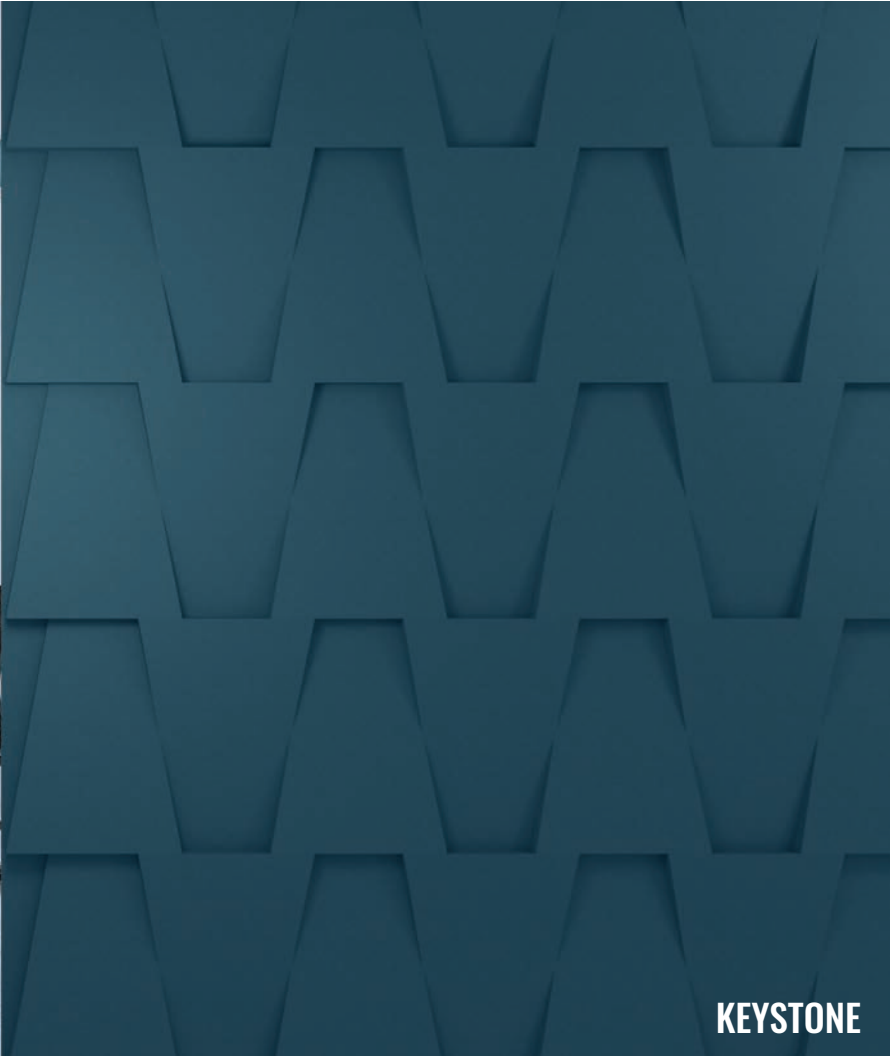

KEYSTONE



WEDGE



WEDGE

SLEEK AND REFINED. Sonic Design Form

Wedge is an ideal option for a clean and polished look. These boards are available in different sizes and configurations. Lay them out vertically or horizontally for added design variations.

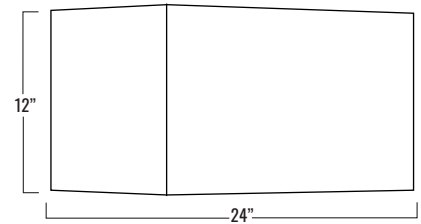
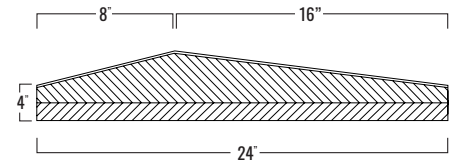

Available in three standard sizes: Small, Medium and Large.
Custom sizes can be special ordered.

PLANK

FUN AND FLEXIBLE. If you're looking for a unique way to introduce texture to room, the Sonic Design Form Plank provides a unique way to introduce texture to a room. You can combine these boards in different configurations and lay them out vertically or horizontally. These can be covered in acoustical fabric or wood veneer offering you endless design options.

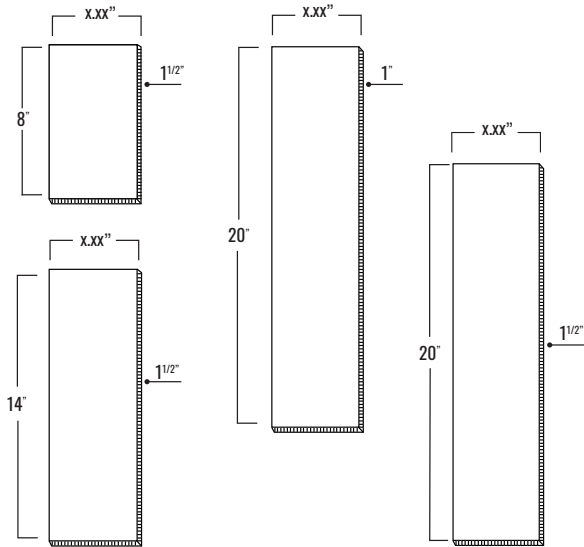

Available in Multiple Sizes, 1"-2" thickness. Planks can be configured to create unique horizontal or vertical patterns.





PLANK

ROTOFAST SNAP-ON

Typical Rotofast
placement for
48" x 96" Panels

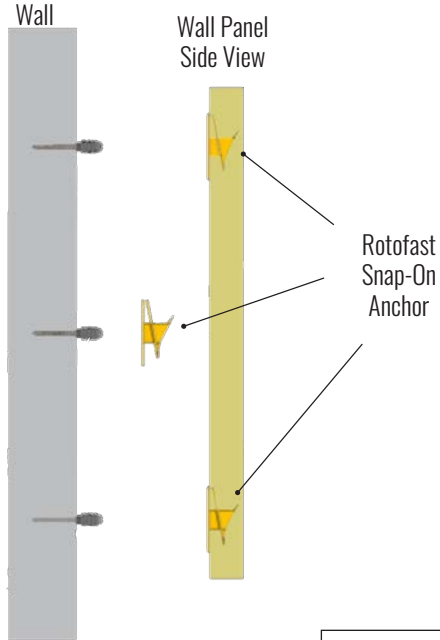

WALL INSTALLATION



Note: Drywall anchors
MUST be used
during install.

ADHESIVE/IMPALING CLIP MOUNT

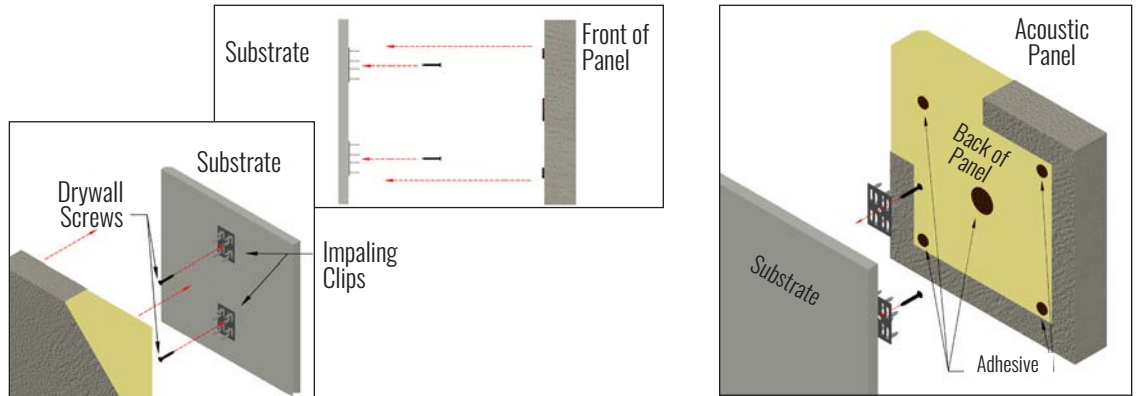

CEILING INSTALLATION

L BRACKET

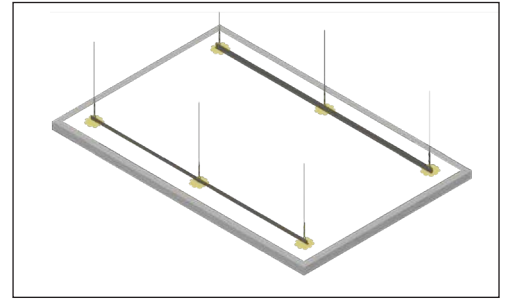
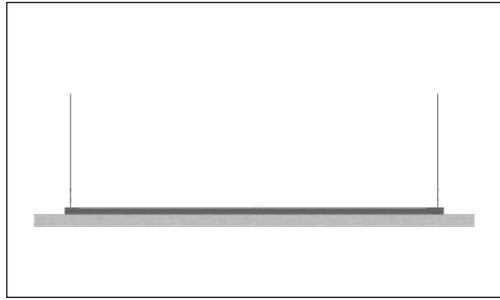
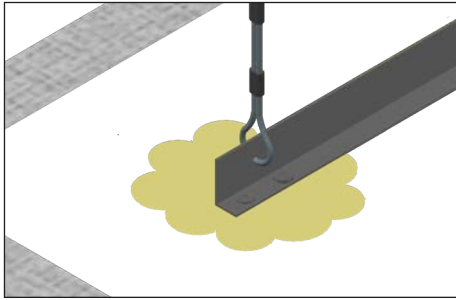

ROTOFAST EYE HOOK

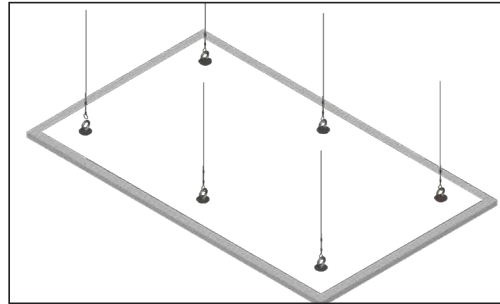
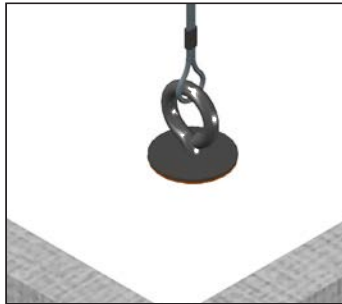
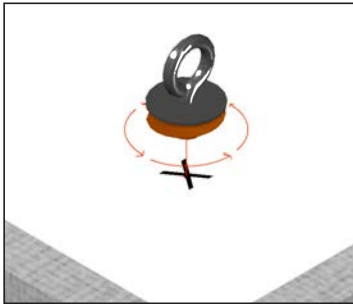

SUSTAINABILITY





LEED OBJECTIVES

LAMVIN, Inc. strives to be a leader in not only our own environmental efforts and contributions, but also to help our clients achieve the same objectives. We help our customers attain the LEED points and credits required for sustainable green buildings pioneered by the US Green Building Council (USGBC). Not only do our products help our customers achieve LEED objectives, but our manufacturing processes and materials go beyond the minimal requirements established by the USGBC.





LAMVIN'S ENVIRONMENTAL INITIATIVES:

-  Adhesives used in our manufacturing process have zero VOC's emitting no harmful chemicals into the air.
-  Our large format CAD driven waterjet machine used for custom and large production jobs allows for perfect accuracy, highest material yield and virtually no production errors, once again, diverting unnecessary waste from our landfills.
-  Our 57,000 sf manufacturing plant has been completely retrofitted with energy saving lighting with motion sensors.
-  Our computer driven product manufacturing process optimizes all jobs for minimal waste, diverting that waste from our landfills.

PRODUCT SHOWN | DIAMOND



www.lamvin.com



 A CATALYST ACOUSTICS GROUP COMPANY

LAMVIN